

# OPERATION MANUAL

## Tri-thermal Wire Controller

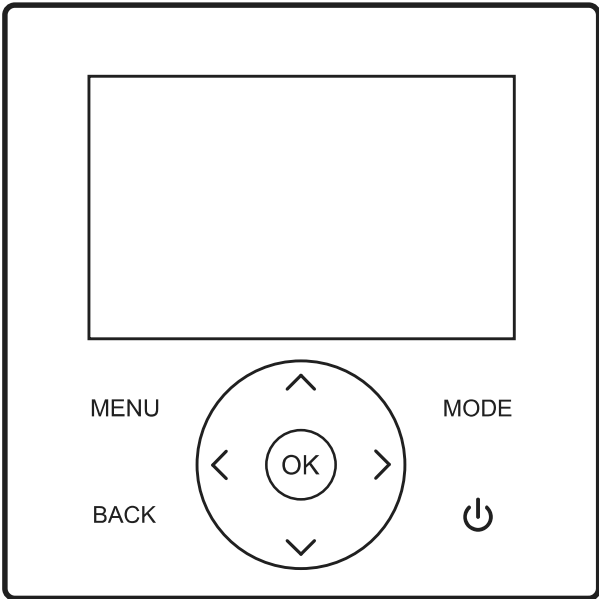

**IMPORTANT NOTE:**

Thank you very much for purchasing our product.  
Before using your unit, please read this manual carefully and keep it for future reference

This manual gives detailed description of the precautions that should be brought to your attention during operation.  
In order to ensure correct service of the wire controller please read this manual carefully before using the unit.  
For convenience of future reference, keep this manual after reading it.

---

# CONTENTS

<b>I. Introduction to the wire controller</b> .....	01
1. Scope of application .....	01
2. Appearance .....	01
3. Key description .....	01
4. Main page display .....	01
5. Explanation of display icons .....	02
6. Connection of the wire controller with the indoor unit.....	03
<b>II. Explanation of display items</b> .....	03
1. Initial state .....	03
2. Buzzer state .....	03
3. Backlight display (10-level gradual change in backlight).....	04
4. Home page display.....	04
<b>III. Explanation of keys</b> .....	05
1. [MODE] key .....	05
2. [UP], [DOWN], [LEFT], [RIGHT] keys.....	05
3. [ON/OFF] key .....	06
4. [BACK] key .....	06
5. [MENU] key .....	06
<b>IV. Explanation of menus</b> .....	06
1. Main menu display .....	06
2. Operation mode display .....	06
3. Zone setting.....	06
4. DHW setting .....	08
5. Function lock .....	08
6. Options .....	09
7. Date, time and timing function setting .....	10
8. Settings .....	11
9. Parameter query.....	13
10. Error query.....	13
11. APP and reset WiFi .....	13
12. Program version query .....	14
13. Thermostat control.....	14

- V. Auxiliary functions** .....14
  - 1. Child lock .....14
  - 2. Double wire controller control .....14
  
- VI. Appendixes**.....15
  - 1. Parameter query .....15
  - 2. Parameter setting .....16
  - 3. Restoring to factory default settings .....23
  - 4. Error query .....23
  - 5. Error list .....24
  
- VII. Installation instructions** .....26
  - 1. Material chart list .....26
  - 2. Installation procedure .....26

# I. Introduction to the wire controller

## 1. Scope of application

This is a wire controller for CCHD (Combined Cooling, Heating and DHW) supply, applicable to the models belonging to the CCHD Supply Project.

## 2. Appearance

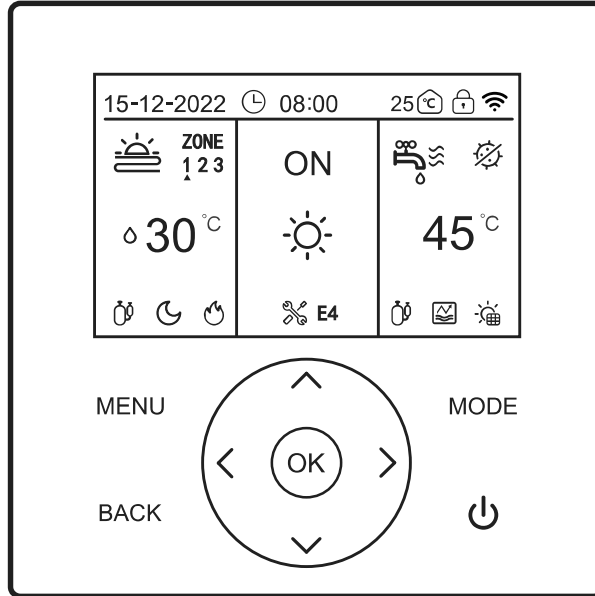







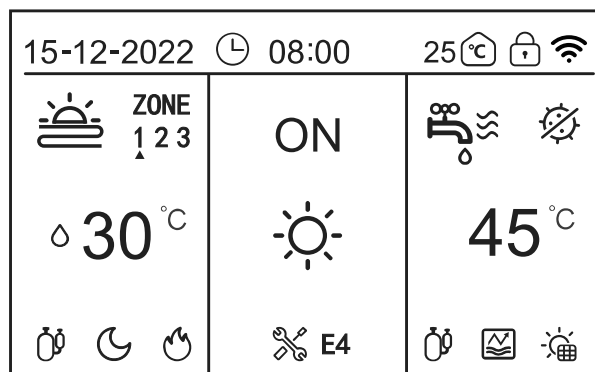





















## 3. Key description









Name	[MENU] key	[ON/OFF] key	[BACK] key	[MODE] key	[UP] key	[DOWN] key	[LEFT] key	[RIGHT] key	[OK] key
Icon	MENU		BACK	MODE					OK

## 4. Main page display



## 5. Explanation of display icons

Mark No.	Module	Content description		Function explanation
1	Upper modules	15-12-2022	Date	It means the date in the format of DDMMYYYY, displayed by default.
2		08:00	Time	It means the time of 24-Hour clock, displayed by default.
3			Daily timer	This icon will be displayed when the Daily Timing function is effective.
4			Weekly timer	This icon will be displayed when the Weekly Timing function is effective.
5			Indoor ambient temperature	It means the indoor ambient temperature, displayed by default.
6			Child lock	This icon will be displayed when the child lock is effective.
7			WiFi	This icon will be displayed after Wi-Fi networking is successful.
8	Middle modules		[HEAT] mode	In the [HEAT] mode, it can switch on the floor heating system or the heating radiator.
9			[COOL] mode	In the [COOL] mode, it can switch on the fan coil or the floor cooling system.
10			[AUTO] mode	In the [AUTO] mode, it can automatically judge the operation modes according to the ambient temperatures.
11		OFF	Power-off	In a state of power-off, the word "OFF" will be displayed.
12		ON	Power-on	In a state of power-on, the word "ON" will be displayed.
13			Floor heating/cooling system (OFF)	It means that the floor heating system is switched off.
14			Floor heating system (ON)	It means that in the [HEAT] mode, it is displayed according to the set function.
15			Floor cooling system (ON)	In cooling mode, this icon will be displayed according to the setting function.
16			Heating radiator (OFF)	It means that the heating radiator is switched off.
17			Heating radiator (ON)	It means that in the [HEAT] mode, it is displayed according to the set function.
18			Fan coil (OFF)	It means that the fan coil is switched off.
19			Fan coil (ON)	It means that the fan coil is turned on.
20			Set ambient temperature	Set ambient temperature.
21			Set water temperature	Set water-side temperature.
22			DHW (OFF)	DHW function is switched off.
23			DHW (ON)	DHW function is switched on.
24			Solar heater	It means the solar heater function is working.
25		Sterilization	It means that sterilization mode of DHW is on.	
26	45 <sup>°C</sup>	DHW zone outlet Temperature	It means the DHW zone outlet temperature, displayed by default.	
27	Lower modules		Fault	In case of a fault, both this icon and the fault code will be displayed.
28			Compressor	This icon will be displayed when the compressor is started.
29			Water pump	This icon will be displayed when the water pump is started.
30			Electrical heater	This icon will be displayed when the electrical heater is started.
31			Anti-freezing protection	This icon will be displayed after the machine is under anti-freezing protection.
32			[DEFROST] mode	This icon will be displayed when the machine is in the [DEFROST] mode.
33			[Holiday Home] mode	This icon will be displayed when the holiday home mode is switched on.
34			[Holiday away] mode	This icon will be displayed when the holiday away mode is switched on.

Label	Module	Content description	Function description	
35	Lower module		Free electricity consumption	Smart grid function, shows different electricity usage conditions.
36			Off-peak electricity consumption	
37			Peak electricity consumption	
38			Auxiliary heat source	It is based on dry-contact signals; this icon is displayed when it receives a signal.(For example, when a gas stove is working for heating)
39			[SILENT] mode	This icon will be displayed when the silent mode is effective.
40			[ECO] mode	This icon will be displayed when the ECO mode is effective.
41			Water tank electrical heater	This icon will be displayed when the water tank electrical heater (auxiliary heat source) is switched on.
42			Emergency mode running	This icon will be displayed when product running in emergency mode.

Remarks:

When an icon is displayed, it means that the corresponding function/system/device is switched on and vice versa;

Functions in the cooling mode: the fan coil is switched on and off; the floor cooling system is switched on and off;

Functions in the heating mode: the fan coil/floor heating system/the heating radiator is switched on and off;

Functions in the automatic mode: it automatically judges the operation modes according to the ambient temperatures.

## 6. Connection of the wire controller with the monobloc

### 6.1. One-to-one control

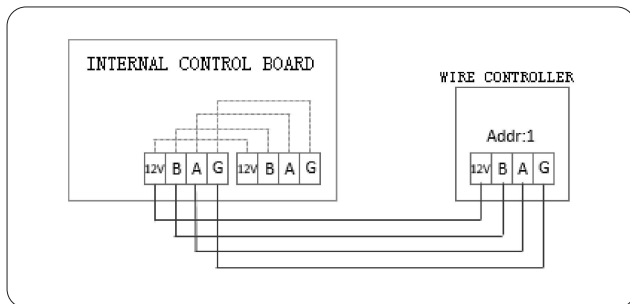

### 6.2. Two-to-one control

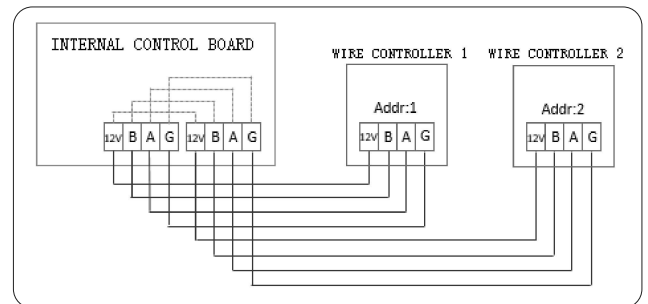

## II. Explanation of display items

### 1. Initial state

After the wire controller is powered on, its display screen will display "loading,please wait"; after the loading process is completed, it will automatically enter the general page.

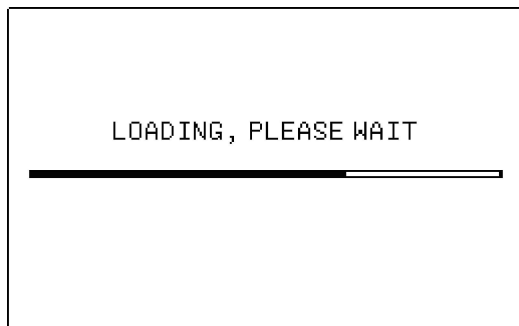

### 2. Buzzer state

In the default state: when the key is pressed, the buzzer will give a short beep. The sound of buzzer can be turned off in the setting.

### 3. Backlight display (10-level gradual change in backlight)

- 1) When the backlight goes out, if any key is pressed, the backlight will change from the state of going out to the state of maximum luminance and system will not respond to this operation.
- 2) When the last key pressing starts timing, if the key is not pressed for 15 seconds, the backlight will gradually change from the state of maximum luminance to the state of half maximum luminance.
- 3) The timing starts from the backlight changes to the state of half maximum luminance; if the key is not pressed for 105 seconds, the backlight will gradually change from the state of half maximum luminance to the state of going out; however, if the key is pressed during such/this period, the backlight will immediately change to the state of maximum luminance and the timing will restart.
- 4) When the backlight is in the state of maximum luminance or half maximum luminance, the key is in the state of being awakened and it will respond to any operation.

### 4. Home page display

Patterns displayed on the home page: fan coil/floor heating system/floor cooling system/the heating radiator zone switching on/off, set temperature, DHW zone outlet temperature, mode, main power on/off, effective functions (date, time, timer state, indoor temperature, child lock, Wi-Fi state), fault icon + fault code, load states (compressor, water pump, auxiliary electric heater), anti-freezing, holiday mode, etc.

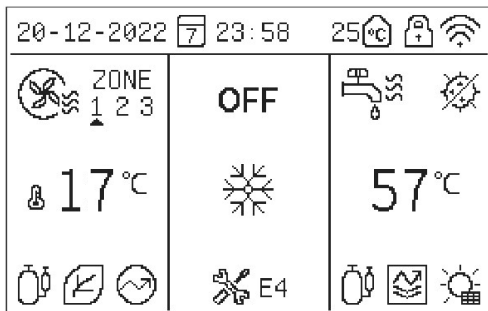

Three-zone-mode Running Interface

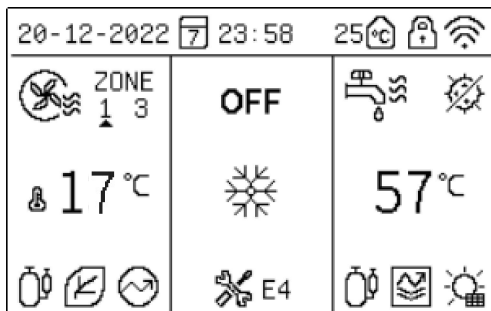

Two-zone-mode Running Interface

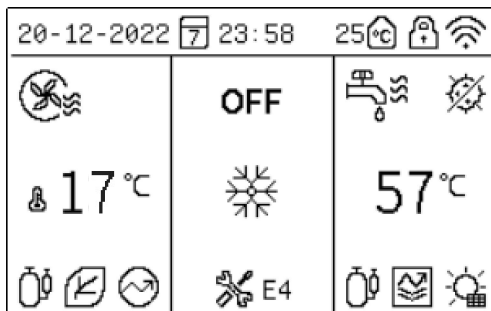

One-zone-mode Running Interface

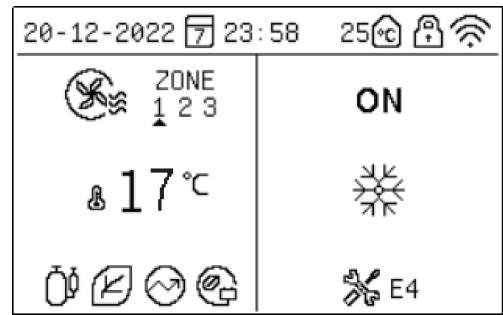

Running interface when the DHW mode is disabled.

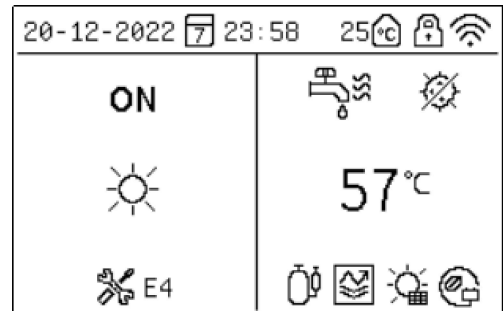

Running interface in the only water heating mode on.

Explanation of display items:

(1) Normally, if no state is chosen, the fan coil/floor heating system zone will display the set temperature and the DHW zone will display the outlet temperature.

When the equipment status is displayed (that is, no temperature zone is controlled), the actual display examples are as follows:

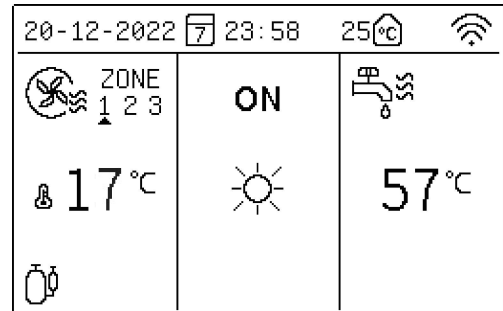

↓ 5s

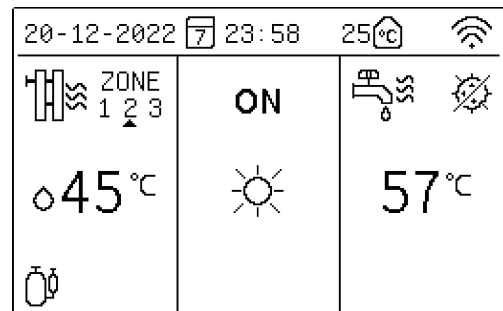

↓ 5s

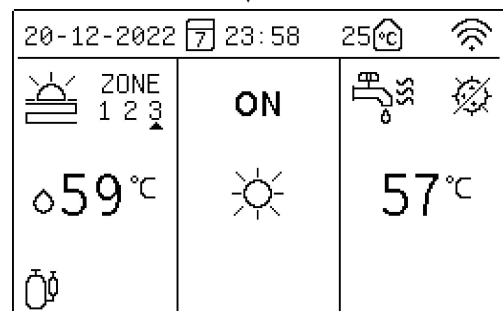

Note: It displays the status and the set temperature of next zone every 5 seconds.

### III. Explanation of keys

#### 1. [MODE] key

When the wire controller is powered on for the first time, the heating mode is switched off by default. On the home page, when you quickly press the [MODE] key, the mode icon zone will switch to next mode. switching sequence:

HEAT	COOL	AUTO

#### 2. [UP], [DOWN], [LEFT], [RIGHT] keys

On the home page, you can choose any temperature zones needed control by pressing the [ < ] or [ > ] key and then adjust the temperature by pressing the [ ^ ] or [ v ] key.

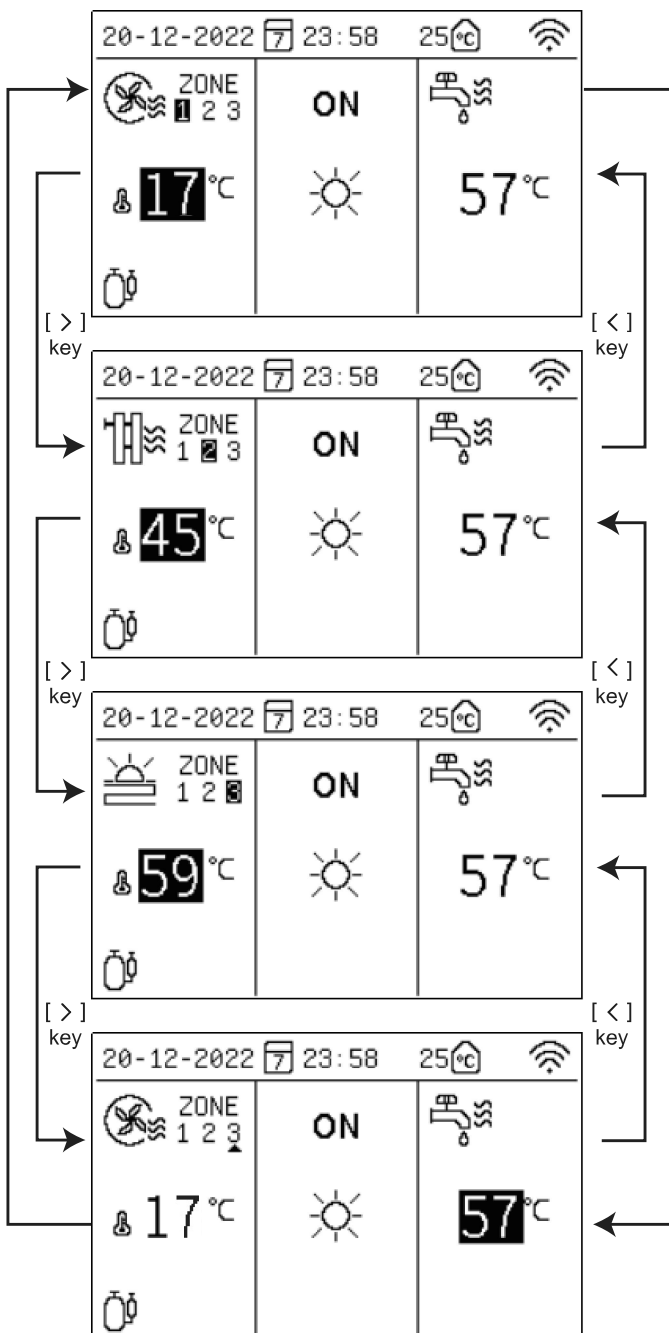

The temperature zone on the left side is the fan coil/floor heating/ floor cooling temperature zone and the one on the right side is the DHW temperature zone.

#### Slow adjustment (short key pressing):

When you press the [ ^ ] key once, the set temperature value will flash with a frequency of 1Hz and the set temperature will increase by 1°C/1°F.

When you press the [ v ] key once, the set temperature value will flash with a frequency of 1Hz and the set temperature will decrease by 1°C/1°F.

#### Quick adjustment

When you continuously press the [ ^ ] key for more than 0.6s, the set temperature value will always light and the set temperature will progressive increase by 1°C/1°F quickly and automatically; after you release the key, the set temperature value will flash with a frequency of 1Hz and the set temperature will stop the automatic progressive increase.

When you continuously press the [ v ] key for more than 0.6s, the set temperature value will always light and the set temperature will progressively decrease by 1°C/1°F quickly and automatically; after you release the key, the set temperature value will flash with a frequency of 1Hz and the set temperature will stop the automatic progressive decrease.

**Note:** The set fan coil, floor cooling, floor heating and the heating radiator temperature values are backed up independently; when the device enters the same modes next time, it will display the last set temperature values of the corresponding modes.

#### Water temperature adjusting range:

Model	Running zone	Degrees centigrade (°C)		Fahrenheit °F	
		Set range	Initial value	Set range	Initial value
Automatic	Automatic cooling/heating judgment	Automatic cooling/heating judgment	Automatic cooling/heating judgment	Automatic cooling/heating judgment	Automatic cooling/heating judgment
Cooling	Fan coil	5 ~ 20	10	41 ~ 68	50
	Floor cooling	18 ~ 25	18	64 ~ 77	64
Heating (R290)	Fan coil	25 ~ 80	45	77 ~ 176	113
	The heating radiator	25 ~ 80	55	77 ~ 176	131
	Floor heating	25 ~ 45	35	77 ~ 113	95
Heating (R32)	Fan coil	25 ~ 65	45	77 ~ 149	113
	The heating radiator	25 ~ 65	55	77 ~ 149	131
	Floor heating	25 ~ 45	35	77 ~ 113	95
Water heating(R290)	/	20 ~ 70	45	68 ~ 158	113
Water heating(R32)	/	20 ~ 60	45	68 ~ 140	113

#### Indoor temperature adjusting range:

Model	Running zone	Degrees centigrade (°C)		Fahrenheit °F	
		Set range	Initial value	Set range	Initial value
Automatic	Automatic cooling/heating judgment	Automatic cooling/heating judgment	Automatic cooling/heating judgment	Automatic cooling/heating judgment	Automatic cooling/heating judgment
Cooling	Fan coil	16 ~ 31	26	61 ~ 88	79
	Floor cooling	16 ~ 31	26	61 ~ 88	79
Heating (R290)	Fan coil	16 ~ 31	20	61 ~ 88	68
	The heating radiator	16 ~ 31	20	61 ~ 88	68
	Floor heating	16 ~ 31	20	61 ~ 88	68
Heating (R32)	Fan coil	16 ~ 31	20	61 ~ 88	68
	The heating radiator	16 ~ 31	20	61 ~ 88	68
	Floor heating	16 ~ 31	20	61 ~ 88	68
Water heating(R290)	/	20 ~ 70	45	68 ~ 158	113
Water heating(R32)	/	20 ~ 60	45	68 ~ 140	113

### 3. [ON/OFF] key

On the home page, please press the [ < ] or [ > ] key to enter the temperature zone setting and press the [ ⏻ ] key to operate.

On the zone setting page, in the status of zone switching off, if you quickly press the [ ⏻ ] key, the zone will be switched on.

On the zone setting page, in the status of zone switching on, if you quickly press the [ ⏻ ] key, the zone will be switched off.

### 4. [BACK] key

If you quickly press the [BACK] key, it will go back to the previous menu.

### 5. [MENU] key

On the home page, if you quickly press the [MENU] key, it will enter the main menu page.

## IV. Explanation of menus

### 1. Main menu display



MENU		1/2
OPERATION MODE		
SETTING OF THE ZONE		
DHW SETTING		
FUNCTION LOCK		
OPTION		
TIME AND TIMER SETTING		
OK	^v	BACK

MENU		2/2
PARAMETERS CONFIG		
PARAMETER QUERY		
HISTORY ERROR		
RESET WIFI		
VERSION QUERY		
OK	^v	BACK

You can choose the relevant menus by pressing the [ ^ ] or [ v ] key and then enter the menus by pressing the [OK] key.

### 2. Operation mode display

OPERATION MODE		1/1
Operation Mode Setting:		
		
HEAT	COOL	AUTO
OK	<>	BACK

There are three modes, namely "HEAT", "COOL" and "AUTO". You can choose the modes by pressing the [ < ] or [ > ] key, keep the setting results by pressing the [OK] key or the [MENU] key and [ ⏻ ] then go back to the main page by pressing the [BACK] key or the [ ⏻ ] key.

In the [HEAT] mode, the display content is as follows:

OPERATION MODE		1/1
Operation Mode Setting:		
		
HEAT		
OK	<>	BACK

In the [COOL] mode, the display content is as follows:

OPERATION MODE		1/1
Operation Mode Setting:		
		
COOL		
OK	<>	BACK

### 3. Zone setting

3.1. When the zone is used as the fan coil zone, the page will display the following content:

ZONE 1-FAN COIL UNIT		1/1
1. CURRENT STATE	OFF	
2. USE SETTING TEMP	WATER TEMP	
3. SET WATER TEMP	35℃	
4. SET AMBIENT TEMP	35℃	
5. AUXILIARY ELECTRIC HEATING	OFF	
OK	^v<>	BACK

The fan coil zone setting mainly includes the fan coil switching on/off setting and the temperature value setting.

In the fan coil zone, you can set and use the set temperature to control the indoor temperature; if you choose the [WATER TEMP], the indoor temperature will be the water-side temperature; if you choose the [AMBIENT TEMP], the indoor temperature will be the indoor ambient temperature; both the set water-side temperature and the set ambient temperature are the shutdown temperatures of the fan coil zone on the premise of reaching the set temperatures.

When the [5.AUXILIARY ELECTRIC HEATING] in the fan coil zone is set to be switched on, after the fan coil zone is switched on, the auxiliary electric heater will be compulsorily switched on.

3.2. When the zone is used as the floor heating system zone, the page will display the following content:

ZONE 2-FLOOR HEATING		1/2
1. CURRENT STATE	OFF	
2. USE SETTING TEMP	WATER TEMP	
3. SET WATER TEMP	35℃	
4. SET AMBIENT TEMP	35℃	
5. AUXILIARY ELECTRIC HEATING	OFF	
OK	^v<>	BACK

The floor heating system zone setting mainly includes the floor heating system switching on/off setting and the temperature value setting.

In the floor heating system zone, you can set and use the set temperature to control the indoor temperature; if you choose the [WATER TEMP], the indoor temperature will be the water-side temperature; if you choose the [AMBIENT TEMP], the indoor temperature will be the indoor ambient temperature; both the set water-side temperature and the set ambient temperature are the shutdown temperatures of the floor heating system zone on the premise of reaching the set temperatures.

When the [5.AUXILIARY ELECCTRIC HEATING] is ON, after the floor heating system zone is switched on, the auxiliary electric heater will be compulsorily switched on.

**3.3. When the zone is used as the floor cooling system zone, the page will display the following content:**

ZONE 2-FLOOR COOLING		1/1
1. CURRENT STATE	OFF	
2. USE SETTING TEMP	WATER TEMP	
3. SET WATER TEMP	35°C	
4. SET AMBIENT TEMP	35°C	
OK	^V<>	BACK

The floor cooling system zone setting mainly includes the floor cooling system switching on/off setting and the temperature value setting.

In the floor cooling system zone, you can set and use the set temperature to control the indoor temperature; if you choose the [WATER TEMP], the indoor temperature will be the water-side temperature; if you choose the [AMBIENT TEMP], the indoor temperature will be the indoor ambient temperature; both the set water-side temperature and the set ambient temperature are the shutdown temperatures of the floor cooling system zone on the premise of reaching the set temperatures.

**3.4. When the zone is used as the heating radiator zone, the page will display the following content:**

ZONE 3-RADIATOR		1/1
1. CURRENT STATE	OFF	
2. USE SETTING TEMP	WATER TEMP	
3. SET WATER TEMP	35°C	
4. SET AMBIENT TEMP	35°C	
5. AUXILIARY ELECTRIC HEATING	OFF	
OK	^V<>	BACK

The heating radiator zone setting mainly includes the heating radiator switching on/off setting and the temperature value setting.

In the heating radiator zone, you can set and use the set temperature to control the indoor temperature; if you choose the [WATER TEMP], the indoor temperature will be the water-side temperature; if you choose the [AMBIENT TEMP], the indoor temperature will be the indoor ambient temperature; both the set water-side temperature and the set ambient temperature are the shutdown temperatures of the heating radiator zone on the premise of reaching the set temperatures.

When the [5.AUXILIARY ELECCTRIC HEATING] is ON, after the heating radiator zone is switched on, the auxiliary electric heater will be compulsorily switched on.

**3.5. Weather temperature control interface:**

WEATHER TEMP SETTING		1/2
1. ZONE 1 TEMP	OFF	
2. ZONE 1 COOL TEMP TYPE	00	
3. ZONE 1 HEAT TEMP TYPE	00	
4. ZONE 2 TEMP	OFF	
5. ZONE 2 COOL TEMP TYPE	00	
6. ZONE 2 HEAT TEMP TYPE	00	
OK	^V<>	BACK

WEATHER TEMP SETTING		2/2
7. ZONE 3 TEMP	OFF	
8. ZONE 3 COOL TEMP TYPE	00	
9. ZONE 3 HEAT TEMP TYPE	00	
OK	^V<>	BACK

There are 18 temperature curves for weather-controlled cooling and heating respectively; therefore, please refer to the attached figures for the actual curves.

You can choose the entry or exit from the setting by pressing the [ < ] or [ > ] key or the [OK] key, and then set the parameters by pressing the [ ^ ] or [ v ] key and saving the setting results by pressing the [OK] key.

Table of Cooling Ambient Temperatures - Target Water Temperatures (Unit: °C)

NO.	T Outer-ring temperature	-10≤TA<15	15≤TA<22	22≤TA<30	30≤TA
0	Low temperature curve 1	16	11	8	5
1	Low temperature curve 2	17	12	9	6
2	Low temperature curve 3	18	13	10	7
3	Low temperature curve 4	19	14	11	8
4	Low temperature curve 5	20	15	12	9
5	Low temperature curve 6	21	16	13	10
6	Low temperature curve 7	22	17	14	11
7	Low temperature curve 8	23	18	15	12
8	Low temperature curve 9	Set in engineering settings			
9	High temperature curve 1	20	18	17	16
10	High temperature curve 2	21	19	18	17
11	High temperature curve 3	22	20	19	17
12	High temperature curve 4	23	21	19	18
13	High temperature curve 5	24	21	20	18
14	High temperature curve 6	24	22	20	19
15	High temperature curve 7	25	22	21	19
16	High temperature curve 8	25	23	21	20
17	High temperature curve 9	Set in engineering settings			

Table of Heating Ambient Temperatures - Target Water Temperatures (Unit: °C)

NO.	T outdoor ambient	-20	-19	-18	-17	-16	-15	-14	-13	-12	-11	-10	-9	-8	-7	-6	-5	-4	-3	-2	-1	0
0	Low temperature curve 1	38	38	38	38	37	37	37	37	37	37	36	36	36	36	36	35	35	35	35	35	35
1	Low temperature curve 2	37	37	37	37	36	36	36	36	36	36	35	35	35	35	35	35	34	34	34	34	34
2	Low temperature curve 3	36	36	36	35	35	35	35	35	35	34	34	34	34	34	33	33	33	33	33	33	33
3	Low temperature curve 4	35	35	35	34	34	34	34	34	34	33	33	33	33	33	32	32	32	32	32	32	32
4	Low temperature curve 5	34	34	34	33	33	33	33	33	33	32	32	32	32	32	31	31	31	31	31	31	31
5	Low temperature curve 6	32	32	32	31	31	31	31	31	31	31	31	31	30	30	30	30	30	30	30	30	29
6	Low temperature curve 7	31	31	31	31	30	30	30	30	30	30	30	30	29	29	29	29	29	29	29	29	28
7	Low temperature curve 8	29	29	29	29	28	28	28	28	28	28	28	28	27	27	27	27	27	27	27	27	26
8	Low temperature curve 9	Set in engineering settings																				
9	High temperature curve 1	55	55	55	54	54	54	54	54	54	54	54	53	53	53	53	53	53	53	53	53	52
10	High temperature curve 2	53	53	53	52	52	52	52	52	52	52	51	51	51	51	51	51	51	51	51	51	50
11	High temperature curve 3	52	52	52	51	51	51	51	51	51	51	51	50	50	50	50	50	50	50	50	50	49
12	High temperature curve 4	50	50	50	49	49	49	49	49	49	49	49	49	48	48	48	48	48	48	48	48	47
13	High temperature curve 5	48	48	48	47	47	47	47	47	47	47	47	46	46	46	46	46	46	46	46	46	45
14	High temperature curve 6	45	45	45	44	44	44	44	44	44	44	44	44	43	43	43	43	43	43	43	43	42
15	High temperature curve 7	43	43	43	42	42	42	42	42	42	42	42	42	41	41	41	41	41	41	41	41	40
16	High temperature curve 8	40	40	40	39	39	39	39	39	39	39	39	39	38	38	38	38	38	38	38	38	37
17	High temperature curve 9	Set in engineering settings																				
NO.	T outdoor ambient	1	2	3	4	5	6	7	8	9	10	11	12	13	14	15	16	17	18	19	≥20	
0	Low temperature curve 1	35	35	34	34	34	34	34	34	33	33	33	33	33	32	32	32	32	32	32	32	
1	Low temperature curve 2	34	34	33	33	33	33	33	32	32	32	32	32	31	31	31	31	31	31	31	31	
2	Low temperature curve 3	32	32	32	32	32	31	31	31	31	31	31	30	30	30	30	30	29	29	29	29	
3	Low temperature curve 4	31	31	31	31	31	31	30	30	30	30	30	29	29	29	29	29	29	29	29	28	
4	Low temperature curve 5	30	30	30	30	30	29	29	29	29	29	29	28	28	28	28	28	28	28	27	27	
5	Low temperature curve 6	29	29	29	29	29	28	28	28	28	28	28	27	27	27	27	27	27	27	26	26	
6	Low temperature curve 7	28	28	28	28	28	27	27	27	27	27	27	26	26	26	26	26	26	26	25	25	
7	Low temperature curve 8	26	26	26	26	26	25	25	25	25	25	25	25	25	24	24	24	24	24	24	24	
8	Low temperature curve 9	Set in engineering settings																				
9	High temperature curve 1	52	52	52	52	52	51	51	51	51	51	51	51	51	50	50	50	50	50	50	50	
10	High temperature curve 2	50	50	50	50	50	50	49	49	49	49	49	49	49	48	48	48	48	48	48	48	
11	High temperature curve 3	49	49	49	49	49	49	48	48	48	48	48	48	48	47	47	47	47	47	47	47	
12	High temperature curve 4	47	47	47	47	47	47	46	46	46	46	46	46	46	45	45	45	45	45	45	45	
13	High temperature curve 5	45	45	45	45	45	45	44	44	44	44	44	44	44	43	43	43	43	43	43	43	
14	High temperature curve 6	42	42	42	42	42	42	41	41	41	41	41	41	41	40	40	40	40	40	40	40	
15	High temperature curve 7	40	40	40	40	40	40	39	39	39	39	39	39	39	38	38	38	38	38	38	38	
16	High temperature curve 8	37	37	37	37	37	36	36	36	36	36	36	36	36	35	35	35	35	35	35	35	
17	High temperature curve 9	Set in engineering settings																				

#### 4. DHW setting

DHW SETTING		1/1
1. HOT_WATER		OFF
2. USE SETTING TEMP		35°C
3. STERILIZATION TIMER		
4. FORCE HOT WATER		OFF
5. FORCE OPEN T HEAT		OFF
6. DHW PUMP TIMER		
[OK]      ^V<>      [BACK]		

STERILIZATION TIMER		1/1
1. TIMING STERILIZATION		OFF
2. START DATE		MON
3. START TIME		00:00
[OK]      ^V<>      [BACK]		

DHW PUMP				1/1
S/N	START	S/N	START	
1. <input type="checkbox"/>	00:00	4. <input type="checkbox"/>	00:00	
2. <input type="checkbox"/>	00:00	5. <input type="checkbox"/>	00:00	
3. <input type="checkbox"/>	00:00	6. <input type="checkbox"/>	00:00	
[OK]      ^V<>      [BACK]				

The DHW zone setting mainly includes the DHW function ON/OFF setting and the DHW temperature setting as well as some specific functions (sterilization, forced water heating, water tank electric heating) in the DHW mode.

You can choose the entry or exit from the setting by pressing the [ < ] or [ > ] key or the [OK] key, and then set the parameters by pressing the [ ^ ] or [ v ] key and saving the setting results by pressing the [OK] key.

#### 5. Function lock

The child lock is used to prevent children from wrongly operating. The mode setting and temperature adjustment can be locked or unlocked by the child lock function. After you enter the interface "MENU-FUNCTION LOCK", the following content will be displayed:

PASSWORD		1/1
Please input password:		
* * * *		
[OK]      ^V<>      [BACK]		

PASSWORD		1/1
Password error, input again:		
* * * *		
[OK]      ^V<>      [BACK]		

After you input the current password "2345", and the following page will appear:

After you input the current password "2345", and the following page will appear:

FUNCTION LOCK		1/1
1. COOL/HEAT SET TEMP	UNLOCK	
2. COOL/HEAT ON/OFF	UNLOCK	
3. COOL/HEAT MODE SWITCH	UNLOCK	
4. DHW SET TEMP	UNLOCK	
5. DHW POWERED ON/OFF	UNLOCK	
<input type="button" value="OK"/> <span style="margin-left: 100px;">^V&lt;&gt;</span> <input type="button" value="BACK"/>		

You can use the [V], [^][<], [>] and [OK] keys to choose the "LOCK" or "UNLOCK" setting.

- When [COOL HEAT SET TEMP] is locked, it cannot be adjusted.

Heat or cool temp adjust function is locked, confirm unlock?	
<input type="button" value="OK"/>	<input type="button" value="BACK"/>

- When the [COOL HEAT ON/OFF] is locked, it cannot be adjusted.

Heat or cool powered on/off function is locked, confirm unlock?	
<input type="button" value="OK"/>	<input type="button" value="BACK"/>

- When the [COOL/HEAT MODE SWITCH] function is locked, it cannot be adjusted.

Heat or cool mode switch function is locked, confirm unlock?	
<input type="button" value="OK"/>	<input type="button" value="BACK"/>

- When the [DHW SET TEMP] is locked, it cannot be adjusted.

DHW adjust temp function is locked, confirm unlock?	
<input type="button" value="OK"/>	<input type="button" value="BACK"/>

- When the [DHW POWERED ON/OFF] function is locked, it cannot be adjusted.

DHW powered on/off function is locked, confirm unlock?	
<input type="button" value="OK"/>	<input type="button" value="BACK"/>

## 6. Options

OPTION		1/2
1. SILENT MODE		
2. HOLIDAY AWAY		
3. HOLIDAY HOME		
4. FORCE AHS	OFF	
5. ECO MODE		
6. FLOOR HEATING DRY UP	OFF	
<input type="button" value="OK"/> <span style="margin-left: 100px;">^V&lt;&gt;</span> <input type="button" value="BACK"/>		
7. FLOOR HEATING PREHEAT	OFF	

### 6.1. Silent function setting

SILENT MODE		1/1
1. CURRENT STATE	OFF	
2. SILENT LEVEL	Level 1	
3. SILENT TIMER 1	OFF	
4. TIME PERIOD 1	00:00-00:00	
5. SILENT TIMER 2	OFF	
6. TIME PERIOD 2	00:00-00:00	
<input type="button" value="OK"/> <span style="margin-left: 100px;">^V&lt;&gt;</span> <input type="button" value="BACK"/>		

The silent function is divided into two levels, the higher the level the better silent effect. If [CURRENT STATE] select ON, silent timer 1&2 sets OFF, the silent function is used all the time by default. When one timer is on, the silent function will be enabled according to the setting time period.

### 6.2. Holiday away mode setting

HOLIDAY AWAY		1/1
1. CURRENT STATE	OFF	
2. DATE	00.00.00-00.00.00	
3. HEAT	OFF	
4. DHW	OFF	
5. STERILIZATION OF DHW	OFF	
<input type="button" value="OK"/> <span style="margin-left: 100px;">^V&lt;&gt;</span> <input type="button" value="BACK"/>		

If you intend to leave your home on holiday, you can use the holiday away from home mode to realize energy conservation and freeze prevention; you can set the following content:

- 1). Holiday away mode on/off;
- 2). Start date of holiday away;
- 3). End date of holiday away;
- 4). HEAT mode on/off;
- 5). Water heating mode on/off;
- 6). Timed sterilization function on/off.

Note 1: The holiday away mode and the holiday home mode are mutually exclusive and cannot run at the same time, and the holiday away from home mode takes priority over the holiday home mode;

Note 2: Before entering the holiday away from home mode, if the unit has entered the timed sterilization function, it cannot enter the holiday away mode until the timed sterilization process is completed.

You can choose the entry or exit from the setting by pressing the [ < ] or [ > ] key or the [OK] key, and then set the parameters by pressing the [ ^ ] or [ v ] key and saving the setting results by pressing the [OK] key.

### 6.3. Holiday home mode setting

If you intend to stay at home on holiday, you can use the holiday home mode and set a daily timer of holiday home to realize energy conservation and freeze prevention; in addition, you can distinguish the daily timer from previous daily or weekly timers in order not to modify the previously set daily or weekly timers; you can set the following content:

- 1). Holiday home mode on/off;
- 2). Start date of holiday home;
- 3). End date of holiday home;
- 4). Daily timer of holiday home.

HOLIDAY HOME		1/1
1. CURRENT STATE	OFF	
2. DATE	00.00.00-00.00.00	
3. HOLIDAY AT HOME TIMER SET		
OK	^ v < >	BACK

HOLIDAY AT HOME TIMER SET 1/2				
S/N	START	END	MODE	TEMP
1.	<input type="checkbox"/>	00:00	00:00	HEAT 35℃
2.	<input type="checkbox"/>	00:00	00:00	HEAT 35℃
3.	<input type="checkbox"/>	00:00	00:00	HEAT 35℃
4.	<input type="checkbox"/>	00:00	00:00	HEAT 35℃
5.	<input type="checkbox"/>	00:00	00:00	HEAT 35℃
OK	^ v < >			BACK

HOLIDAY AT HOME TIMER SET 2/2				
S/N	START	END	MODE	TEMP
6.	<input type="checkbox"/>	00:00	00:00	HEAT 35℃
OK	^ v < >			BACK

Note 1: The holiday away mode and the holiday home mode are mutually exclusive and cannot run at the same time, and the holiday away mode takes priority over the holiday home mode;

Note 2: Before entering the holiday home mode, if the unit has entered the timed sterilization function, it cannot enter the holiday home mode until the timed sterilization process is completed.

You can choose the entry or exit from the setting by pressing the [ < ] or [ > ] key or the [OK] key, and then set the parameters by pressing the [ ^ ] or [ v ] key and saving the setting results by pressing the [OK] key.

### 6.4. Force auxiliary heat source control

The wire controller can be set to be connected with an auxiliary heat source AHS:

It can be set to compulsorily switch on the auxiliary heat source.

### 6.5. ECO mode setting

ECO MODE		1/1
1. CURRENT STATE	OFF	
2. ECO MODE	STANDARD	
3. ECO TIMER	OFF	
4. TIME PERIOD	00:00-00:00	
OK	^ v < >	BACK

The ECO mode can be set to switch on and off. (ECO, Standard, Turbo,Auto).

### 6.6. Floor heating dry up

After the drying function of the floor heating system is switched on,the unit will execute the drying function of the floor heating system.

### 6.7. Floor heating preheat

After the preheating function of the floor heating system is switched on, the unit will execute the preheating function of the floor heating system.

## 7. Date, time and timing function setting

TIME AND TIMER SETTING			1/1
1. TIME AND DATE	01.01.2023	00:00	
2. ALL OFF TIMER			
3. WEEKLY SCHEDULE SET			
4. DAILY SCHEDULE SET			
OK	^ v < >		BACK

You can choose the entry or exit from the setting by pressing the [ < ] or [ > ] key or the [OK] key, and then set the parameters by pressing the [ < ] or [ > ] key and saving the setting results by pressing the [OK] key.

There are three timing statuses, namely “Disabled”, “Weekly Timing” and “Daily Timing”. When you choose the “Daily Timing” status, the icon [☰] on the home page will be displayed; when you choose the “Weekly Timing” status, the icon [🕒] on the home page will be displayed.

### 7.1. Weekly schedule setting

After entering the weekly timing page, you can choose the daily timing function enabling option by pressing the [ < ] or [ > ] key and then confirm the enabling on or off by pressing the [OK] key, choose the [SET TIME] option by pressing the [ < ] or [ > ] key and then enter the [WEEKLY SCHEDULE SET] by pressing the [OK] key.

And then you can set the parameters by pressing the [ ^ ] or [ v ] key and saving the setting results by pressing the [OK] key.

There are three mode options: [COOL], [HEAT] and [DHW].

WEEKLY SCHEDULE SET							1/3
SUN	MON	TUE	WED	THU	FRI	SAT	
<input type="checkbox"/>	<input type="checkbox"/>	<input type="checkbox"/>	<input type="checkbox"/>	<input type="checkbox"/>	<input type="checkbox"/>	<input type="checkbox"/>	
SET TIME							
OK		^V<>			BACK		

WEEKLY SCHEDULE SET					2/3
S/N	START	END	MODE	TEMP	
1.	<input type="checkbox"/>	00:00	00:00	HEAT	35℃
2.	<input type="checkbox"/>	00:00	00:00	HEAT	35℃
3.	<input type="checkbox"/>	00:00	00:00	HEAT	35℃
4.	<input type="checkbox"/>	00:00	00:00	HEAT	35℃
5.	<input type="checkbox"/>	00:00	00:00	HEAT	35℃
OK		^V<>			BACK

WEEKLY SCHEDULE SET					3/3
S/N	START	END	MODE	TEMP	
6.	<input type="checkbox"/>	00:00	00:00	HEAT	35℃
OK		^V<>			BACK

### 7.2. Daily schedule setting

DAILY SCHEDULE SET					1/2
S/N	START	END	MODE	TEMP	
1.	<input type="checkbox"/>	00:00	00:00	HEAT	35℃
2.	<input type="checkbox"/>	00:00	00:00	HEAT	35℃
3.	<input type="checkbox"/>	00:00	00:00	HEAT	35℃
4.	<input type="checkbox"/>	00:00	00:00	HEAT	35℃
5.	<input type="checkbox"/>	00:00	00:00	HEAT	35℃
OK		^V<>			BACK

DAILY SCHEDULE SET					1/2
S/N	START	END	MODE	TEMP	
6.	<input type="checkbox"/>	00:00	00:00	HEAT	35℃
OK		^V<>			BACK

### 7.3. Clearing all timing settings

On the date and timing setting interface, you can clear the timing settings by pressing the [^], [v] [ < ] and [ > ] keys and then clear or disable the timing function by pressing the [OK] key.

## 8. Parameters settings

PARAMETERS CONFIG		1/1
1. CONFIG PARA-SETTING		
2. SYSTEM PARAMETERS		
3. SPECIAL FUNCTION		
4. MODIFY PASSWORD		
5. RESET		
6. RESTORE FACTORY PASSWORD		
OK		BACK

### 8.1. Wire controller configuration parameter setting

CONFIG PARA-SETTING		1/2
1. SCREEN BRIGHT		00
2. KEY BUZZER		ON
3. CHILD LOCK		OFF
4. LANGUAGE		EN
5. TEMP DISPLAY TYPE		INDOOR
6. TEMP UNIT		℃
OK		BACK

CONFIG PARA-SETTING		2/2
7. RETURN TO HOMEPAGE TIME		00S
8. MASTER/SLAVE SETTINGS		MAS

### 8.2. System parameter setting

Under the system parameter page, you could change the parameters in "USER PARAMETERS SETTING".

Note: "INSTALLER SETTING" and "PROCUDER SETTING" are only open to installer and producer.

SYSTEM PARAMETERS		1/1
1. USER PARAMETERS SETTING		
2. INSTALLER SETTING		
3. PROCUDER SETTING		
OK		BACK

### 8.3. Special function setting

The special function menu is as shown below, including the options of "TRIAL OPERATION FUNCTION", "FORCE DEFROST", "RECYCLE REFRIG".

SPECIAL FUNCTION		1/1
1. TRIAL OPERATION FUNCTION		
2. FORCE DEFROST		OFF
3. RECYCLE REFRIG		OFF
OK	△V<>	BACK

The sub-menu of the "TRIAL OPERATION FUNCTION" is as shown below, including the options of "CHECK AND TEST", "AIR EMPTYING TEST", "PUMP TEST", "COOL TEST", "HEAT TEST" and "HOT WATER TEST".

TRIAL OPERATION FUNCTION		1/1
1. CHECK AND TEST		
2. AIR EMPTYING TEST		OFF
3. PUMP TEST		OFF
4. COOL TEST		OFF
5. HEAT TEST		OFF
6. HOT WATER TEST		OFF
OK	△V<>	BACK

#### 8.3.1. Check and test

On the "CHECK AND TEST" page, you can press the [Up] or [Down] key for selection and then press the [OK] key to confirm the opening or closing of load.

- If the Unit receives the command to turn on the 3-way valve 1, the 3-way valve 1 will remain the "OFF" output; otherwise, it will remain the "ON" output; Same for other three 3-way valves.
- If the Unit receives the command to turn on the Inverter Water Pump will be turned on; otherwise, it will be turned off;
- If the Unit receives the command to turn on the DHW tank electric heater will be turned on; otherwise, it will be turned off;
- If the Unit receives the command to turn on the Auxiliary Electric Heating, the Auxiliary Electric Heating will be turned on; otherwise, it will be turned off.

#### Remarks:

- 1) When the DHW tank electric heater runs, the Auxiliary Electric Heating 1 or the Auxiliary Electric Heating 2 will remain the "OFF" state;
- 2) If a DIP switch is not equipped with the Auxiliary Electric Heating or the Auxiliary Electric Heating 2, the latter will remain the "OFF" state;
- 3) The DHW tank electric heater, the Auxiliary Electric Heating 1 or the Auxiliary Electric Heating 2 will be automatically turned off after running for 5 s.

#### 8.3.2. Air emptying test

When the Unit is in the standby state and receives the command from the Wire Controller to "ENABLE THE AIR EMPTYING TEST", it will enter the function of "AIR EMPTYING TEST".

It will exit from the function of "AIR EMPTYING TEST" when any of the following conditions is met:

- It is disconnected from power supply;
- It receives the command from the Wire Controller to "Disable the AIR EMPTYING TEST";
- It receives next test command.

#### 8.3.3. Pump test

When the Unit receives the command to enable the PUMP TEST, it will enter the function of "PUMP TEST".

It will exit from the function of "PUMP TEST" when any of the following conditions is met:

- It goes wrong with a deficiency of water flow;
- It receives the command from the Wire Controller to "Disable the PUMP TEST";
- It receives next test command.

#### 8.3.4. Cool test

When the Unit receives the command to enable the COOL TEST and when the current energy regulating control temperature is higher than 7°C, it will enter the function of "COOL TEST":

- The target cooling temperature is fixed to be 7°C;
- The inverter water pump, the compressor, the solenoid three-way valves and other components act according to the actual situation.

It will exit from the function of "COOL TEST" when any of the following conditions is met:

- The Unit stops when reaching the temperature threshold;
- It receives next test command;
- It goes wrong for any reason.

#### 8.3.5. Heat test

1) When the Unit receives the command to enable the HEAT TEST and when the current energy regulating control temperature is lower than 35°C, it will enter the function of "HEAT TEST":

- The target heating temperature is fixed to be 35°C;
- The inverter water pump, the compressor, the three-way valves and other components respond according to the actual situation;
- See the Chapter of "Auxiliary Electric Heating" for details about the action logic of the Auxiliary Electric Heating.

It will exit from the function of "HEAT TEST" when any of the following conditions is met:

- The Unit stops when reaching the temperature threshold;
- It receives next test command;
- It goes wrong for any reason.

#### 8.3.6. Hot water test

When the Unit receives the command to enable the HOT WATER TEST and when the current energy regulating control temperature is lower than 55°C, it will enter the function of "HOT WATER TEST":

- The target hot water temperature is fixed to be 55°C;
- The inverter water pump, the compressor, the three-way valves and other components act according to the actual situation;
- See the Chapter of "Water Tank Electric Heater" for details about the action logic of the DHW tank electric heater.

It will exit from the function of "HOT WATER TEST" when any of the following conditions is met:

- The Unit stops when reaching the temperature threshold;
- It receives next test command;
- It receives next test command;
- It goes wrong for any reason.

#### 8.3.7. Force defrost

When the Unit is started and in the "HEAT" mode, if the frost on the heat exchanger of the outdoor unit is thick, the heating effect will be affected; the function of "FORCE DEFROST" can be enabled only in the "HEAT" mode.

On the "SPECIAL FUNCTION SETTING" page of the Wire Controller, if you select "FORCE DEFROST" and set it to [Yes], the whole machine system will be forced to enter the "FORCE DEFROST" operation.

#### 8.3.8. Recycle refig

On the "SPECIAL FUNCTION SETTING" page of the Wire Controller, if you select "RECYCLE REFRIG" mode and set it to [Yes], the whole machine system will enter the "RECYCLE REFRIG" mode.

It can exit from the "RECYCLE REFRIG" mode as long as any of the following conditions is met:

- During refrigerant recycle operation, if the Unit receives the refrigeration non-recycle setting single from the Wire Controller, the Unit will exit from the refrigerant recycle operation and execute the setting of the Wire Controller;

- During the refrigerant recycle operation, if the Unit receives a valid signal from the Wi-Fi network, the Unit will exit from the refrigerant recycle operation and execute the setting of the Wi-Fi network;
- The Unit will automatically exit from the refrigerant recycle operation after refrigerant recycle operation lasts for 10 minutes;
- When the scheduled shutdown time is up, the Unit will exit from the refrigerant recycle operation and enter the standby state.

### 8.4. Password setting

There are three password levels:  
 The user-level password is with the least settable parameters and the factory-level password is with the most settable parameters.  
 The initial user-level password is "2345".  
 Please refer to the parameter setting list for the actual settable content.

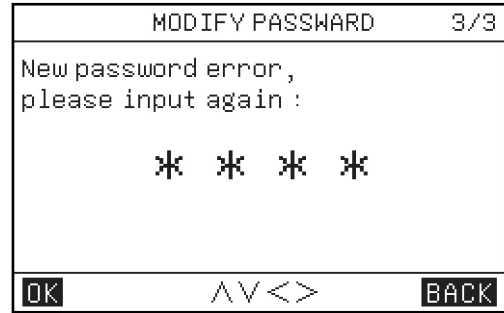
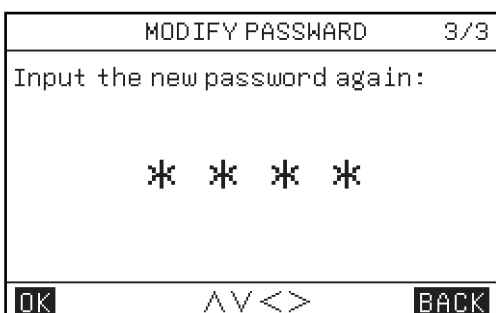
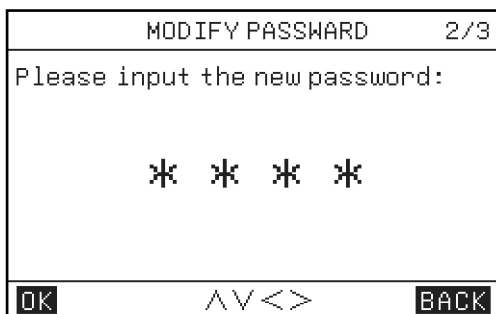
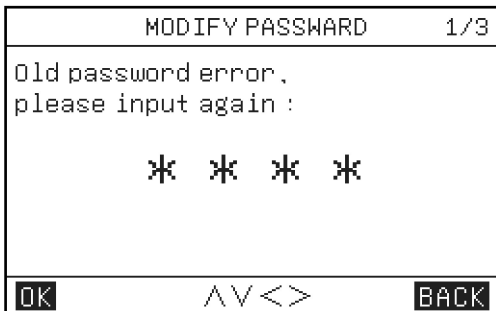
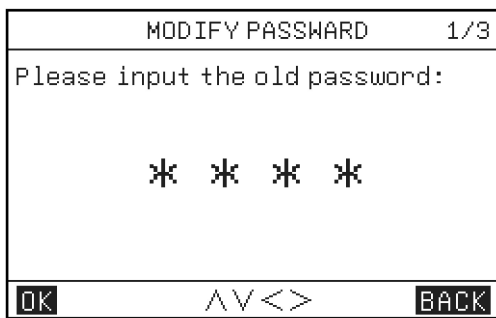

### 8.5. Reset

When reset the parameters, entering the password, all the parameters will restore to factory default setting. (Password will not be restored.)

### 8.6. Restore factory password

If the user forgets the password after changing it, the user can use this function to restore the default password.

### 9. Parameter query

On the parameter query page, there are two secondary menus, namely [Output Query] and [Analog Query].

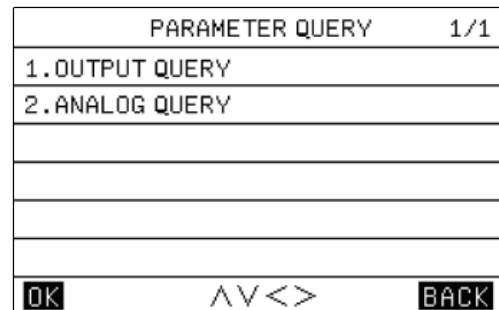

### 10. History Error

On the parameter query page, there are three secondary menus, namely [CURRENT ERROR], [HISTORY ERROR] and [CLEAR HISTORY ERROR]; the maximum number of current and historic faults is 64.

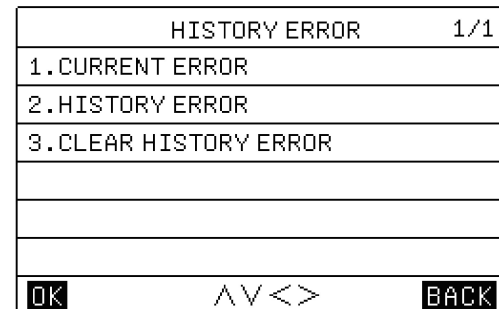

### 11. APP and reset WiFi

#### 11.1. WiFi setting

##### 1) APP download

Download "TSmart" APP from App store or Google Play and install it.

##### 2) Login APP

For the first time to use, please register an account and log in. If the user already registered an account, enter the account password to log in to the APP.

##### 3) Matching network

Method 1:

If you press the [MODE] key and the [V] key of the wire controller for 5 seconds at the same time, you can quickly reset the WiFi. When you hear a beep, release the button. At this time, the wire controller enters the configure network mode.

Method 2:

Enter the menu bar through [MENU], select [RESET WIFI] through [^] and [V], and press [OK] to confirm. The wire controller enters the configure network mode.

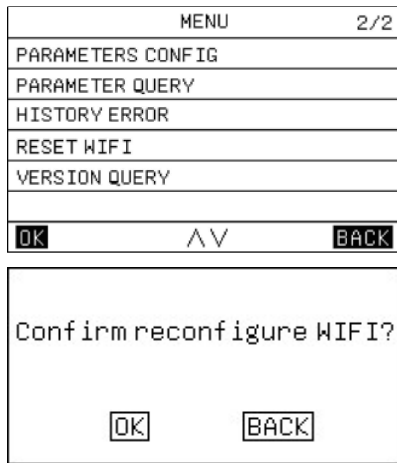

During the network configure process, the WiFi icon flashes. When the network has not been connected to the distribution network for eight consecutive minutes, the WiFi icon goes out. When the WiFi connects successfully, the WiFi icon is always on. When the controller enters the distribution network mode, please use the "TSmart" APP to add devices according to the APP prompt, then you can always use the APP to remotely operate devices.

When the APP need you to scan QR code or put in activation code, see below. Activation code is : TCL QR code is as follows :



## 12. Version query

### Key operations and display:

Go to [MENU]-[VERSION QUERY], and press [OK], the program versions of the current wire controller, indoor unit, and outdoor unit can be queried.

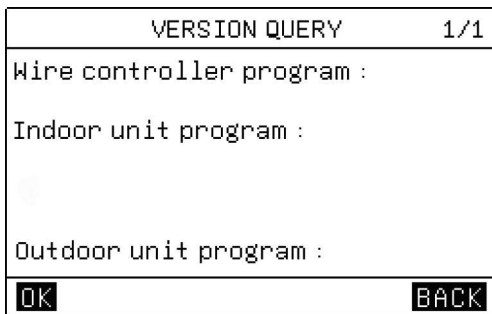

## 13. Thermostat control

If the wire controller is set with enabled thermostats, the on/off command and mode selection will be controlled by the thermostats:

- 1) If one of the thermostats is switched on, the unit will be switched on; if all the thermostats are switched off, the unit will be switched off.
- 2) When any thermostat sends the C signal, the unit will start to operate in the [COOL] mode.
- 3) When any thermostat sends the H signal, the unit will start to operate in the [HEAT] mode.
- 4) When any thermostat fails neither sends the C signal nor sends the H signal, the unit will be in the power-off status.
- 5) When the master control judges that there are two kinds of thermostat signals at the same time, it will judge the operation mode according to the logic of automatic mode wherein the following judgments are made:

- a. When the set mode of one thermostat is the same as the mode judged by the automatic mode, the thermostat will be switched on; otherwise, it will not be switched on.
- b. If the master control judges that the signals fall in the holding area according to the logic of automatic mode, it will send the signals to the outdoor unit according to the heating mode; if the outdoor unit meets the heating start conditions, it will execute the heating mode; otherwise, the outdoor unit will stop because the heating mode reaches the set target.
- 6) When one thermostat is switched on but the operating wire controller is switched off, it means that certain terminal is running and the wire controller can be used for switching off only after the control of the thermostat is canceled.
- 7) When one thermostat is chosen for control, it can control the water temperature only; if the user sets corresponding temperature curves, the user can choose the corresponding curves; if the user fails to choose, "Low Temperature Curve 4" will be used by default.
- 8) The thermostat switching on/off does not affect the relevant control of domestic hot water (DHW).

## V. Auxiliary Functions

### 1. Child lock

When the wire controller is powered on for the first time, the child lock is ineffective by default and the icon [🔒] goes out.

On the home page, when the icon [🔒] goes out, if you continuously press the [OK] key for 5 seconds, the child lock will be effective and the icon [🔒] will light.

On the home page, when the icon [🔒] always lights, if you continuously press the [OK] key, the child lock will be ineffective and the icon [🔒] will go out.

When the child lock is effective, the key operations other than the operation of switching off the child lock will be ineffective, but the icon [🔒] will flash five times with a frequency of 1Hz and a prompt message will pop up to remind the user of the current status of the child lock.

The child lock is valid,  
and you can unlock it by  
long press the [Ok] key  
for 5 seconds.

### 2. Double wire controller control

- (1) The double wire controller function means that one indoor unit bus is connected with two wire controllers.
- (2) When the indoor unit needs to be connected with two wire controllers, it is necessary to set the addresses of the wire controllers through parameter setting; the addresses of two wire controllers must be different in order to realize normal communication.
- (3) If the set statuses (the zone on/off, the set temperature, the set mode, the ECO mode, the auxiliary electric heater control, etc.) of two wire controllers are inconsistent, the wire controller with the last setting change will prevail, and the such wire controller will cover the setting statuses to the other wire controller.

## VI. Appendixes

### 1. Parameter query

1.You can inquire the parameters no matter when the unit is switched on or off.

2.Key operations and display:

(1). Enter the parameter query interface:

In the menu bar, you can select the option [PARAMETER QUERY] to enter the parameter query interface; the time zone will display the parameter code and the inquired parameter code will flash.

(2). Switch the parameter codes: at the moment, you can switch the parameter codes by pressing the [ ^ ] or [ v ] key.

Output query				
S.N.	Name of parameter	Query value	Query range	Remarks
1	RUNNING SIGNAL	Current value	ON/OFF	
2	DEFROST SIGNAL	Current value	ON/OFF	
3	INVERTER COMPRESSOR	Current value	ON/OFF	
4	WATER TANK ELECTRIC HEAT	Current value	ON/OFF	
5	FOUR-WAY VALVE STATUS	Current value	ON/OFF	
6	ELECTRIC CHASSIS HEATING	Current value	ON/OFF	
7	AUXILIARY HEAT SOURCE	Current value	ON/OFF	
8	EXT BACKUP ELECTRIC HEAT	Current value	ON/OFF	
9	ANTIFREEZE HEATING BELT	Current value	ON/OFF	
10	PIPE ELECTRIC HEATING 1	Current value	ON/OFF	
11	PIPE ELECTRIC HEATING 2	Current value	ON/OFF	
12	THREE-WAY VALVE 1	Current value	ON/OFF	
13	THREE-WAY VALVE 2	Current value	ON/OFF	
14	THREE-WAY VALVE 3	Current value	ON/OFF	
15	THREE-WAY VALVE 4	Current value	ON/OFF	
16	MAIN W-PUMP (FC)	Current value	ON/OFF	
17	ZONE 1 WATER PUMP (EXT A)	Current value	ON/OFF	
18	ZONE 2 WATER PUMP (FH B)	Current value	ON/OFF	
19	ZONE 3 WATER PUMP (FH C)	Current value	ON/OFF	
20	SOLAR WATER PUMP	Current value	ON/OFF	
21	PIPE NETWORK R W-PUMP (L)	Current value	ON/OFF	
22	ZONE 1 H THERMOSTAT	Current value	ON/OFF	
23	ZONE 1 C THERMOSTAT	Current value	ON/OFF	
24	ZONE 2 H THERMOSTAT	Current value	ON/OFF	
25	ZONE 2 C THERMOSTAT	Current value	ON/OFF	
26	ZONE 3 H THERMOSTAT	Current value	ON/OFF	
27	ZONE 3 C THERMOSTAT	Current value	ON/OFF	
28	W-TANK E-HEAT FEEDBACK	Current value	ON/OFF	
29	PIPE E-HEAT FEEDBACK	Current value	ON/OFF	
30	SOLAR SIGNAL INPUT	Current value	ON/OFF	
31	FLOW SWITCH	Current value	ON/OFF	
32	SMART GRID (PHOTOVOLTAIC)	Current value	ON/OFF	
33	SMART GRID (GRID)	Current value	ON/OFF	
34	REMOTE SWITCH	Current value	ON/OFF	
35	EF FEEDBACK	Current value	ON/OFF	

Analog quantity query				
S.N.	Name of parameter	Query value	Query range	Remarks
1	DIAL 1 STATE	Current value	0-15	
2	DIAL 2 STATE	Current value	0-15	
3	DIAL 3 STATE	Current value	0-15	
4	TURNTABLE STATUS	Current value	0-15	
5	ZONE 1 INLET WATER TEMP	Current value	-30-100°C	
6	ZONE 2 INLET WATER TEMP	Current value	-30-100°C	
7	ZONE 3 INLET WATER TEMP	Current value	-30-100°C	
8	ZONE 1 INDOOR TEMP	Current value	-30-100°C	
9	ZONE 2 INDOOR TEMP	Current value	-30-100°C	
10	ZONE 3 INDOOR TEMP	Current value	-30-100°C	
11	WATER TANK TEMP	Current value	-30-100°C	
12	PHE I W-TEMP	Current value	-30-100°C	
13	PHE O W-TEMP	Current value	-30-100°C	
14	PIPELINE E-H O W-T	Current value	-30-100°C	
15	PHE REF I TEMP	Current value	-30-100°C	
16	PHE REF O TEMP	Current value	-30-100°C	
17	BALANCE TANK I W-TEMP 1	Current value	-30-100°C	
18	BALANCE TANK I W-TEMP 2	Current value	-30-100°C	
19	SYS FINAL WATER O TEMP	Current value	-30-100°C	
20	SOLAR PANEL TEMP	Current value	-30-100°C	
21	OUTDOOR AMBIENT TEMP	Current value	-30-100°C	
22	CONDENSER O TUBE T(O)	Current value	-30-100°C	
23	EXHAUST TEMP	Current value	-30-100°C	
24	SUNCTION TEMP	Current value	-30-100°C	
25	ZONE 1 INDOOR T TR1 (A)	Current value	-30-100°C	
26	ZONE 2 INDOOR T TR2 (A)	Current value	-30-100°C	
27	ZONE 3 INDOOR T TR3 (A)	Current value	-30-100°C	
28	WATER TANK T THWT (A)	Current value	-30-100°C	
29	O W-T PIPELINE E-H (A)	Current value	-30-100°C	
30	PHE W-TEMP(A)	Current value	-30-100°C	

PERFORMANCE				
S.N.	Name of parameter	Query value	Query range	Remarks
1	COP	Current value	/	
2	EER	Current value	/	
3	HEATING CAPACITY	Current value	/	
4	COOLING CAPACITY	Current value	/	
5	POWER INPUT	Current value	/	
6	TOTAL HEATING CAPA.	Current value	/	
7	TOTAL COOLING CAPA.	Current value	/	
8	TOTAL POWER	Current value	/	
9	CO2 EMISSIONS	Current value	/	

3. Exit from parameter query:

- (1) In the status of parameter query, you can exit from the query status by quickly pressing the [BACK] key at any time.
- (2) In the status of parameter query, you can exit from the query status by pressing the [ ⏏ ] key at any time.

## 2. Parameter setting

1.Remarks:

- (1) The set parameters are required to be memorized;

2.Key operations and display:

(1) Enter the parameter setting interface:

On the main menu page, you need to first select the option [PARAMETERS CONFIG] and then select the option [SYSTEM PARAMETERS] to enter the parameter setting interface.

(2) Switch the parameter code: at the moment, you can switch the parameter code by pressing the [ ^ ] or [ v ] key.

Data classification: [00#module - user parameters]						
SN	First Menu	Secondary Menu	Third Menu	TERMINAL	Default	Range
1	OPERATION MODE	/	/	/	HEAT	COOL
						HEAT
						AUTO
2	ZONE 1 SETTING	CURRENT STATE	/	/	OFF	OFF
				/		ON
		COOLING SET WATER TEMP	/	FAN COIL	10°C	5 ~ 20°C
				FLOOR COOLING	18°C	18 ~ 25°C
		COOLING SET AMBIENT TEMP	/	/	26°C	16 ~ 31°C
		HEATING SET WATER TEMP(R290)	/	FAN COIL	45°C	25 ~ 80°C
				FLOOR HEATING	35°C	25 ~ 45°C
				RADIATOR	55°C	25 ~ 80°C
		HEATING SET WATER TEMP(R32)	/	FAN COIL	45°C	25 ~ 65°C
				FLOOR HEATING	35°C	25 ~ 45°C
				RADIATOR	55°C	25 ~ 65°C
		HEATING SET AMBIENT TEMP	/	/	26°C	16 ~ 31°C
3	ZONE 2 SETTING	CURRENT STATE	/	/	OFF	OFF
				/		ON
		COOLING SET WATER TEMP	/	FAN COIL	10°C	5 ~ 20°C
				FLOOR COOLING	18°C	18 ~ 25°C
		COOLING SET AMBIENT TEMP	/	/	26°C	16 ~ 31°C
		HEATING SET WATER TEMP(R290)	/	FAN COIL	45°C	25 ~ 80°C
				FLOOR HEATING	35°C	25 ~ 45°C
				RADIATOR	55°C	25 ~ 80°C
		HEATING SET WATER TEMP(R32)	/	FAN COIL	45°C	25 ~ 65°C
				FLOOR HEATING	35°C	25 ~ 45°C
				RADIATOR	55°C	25 ~ 65°C
		HEATING SET AMBIENT TEMP	/	/	26°C	16 ~ 31°C
4	ZONE 3 SETTING	CURRENT STATE	/	/	OFF	OFF
				/		ON
		COOLING SET WATER TEMP	/	FAN COIL	10°C	5 ~ 20°C
				FLOOR COOLING	18°C	18 ~ 25°C
		COOLING SET AMBIENT TEMP	/	/	26°C	16 ~ 31°C
		HEATING SET WATER TEMP(R290)	/	FAN COIL	45°C	25 ~ 80°C
				FLOOR HEATING	35°C	25 ~ 45°C
				RADIATOR	55°C	25 ~ 80°C
		HEATING SET WATER TEMP(R32)	/	FAN COIL	45°C	25 ~ 65°C
				FLOOR HEATING	35°C	25 ~ 45°C
				RADIATOR	55°C	25 ~ 65°C
		HEATING SET AMBIENT TEMP	/	/	26°C	16 ~ 31°C

Data classification: [00#module - user parameters]						
SN	First Menu	Secondary Menu	Third Menu	TERMINAL	Default	Range
5	DHW SETTING	STERILIZATION TIMER	STERILIZATION TIMER	/	OFF	OFF
						ON
			START DATE	/	MON	MON
						TUE
		WED				
		THU				
		FRI				
		SAT				
					SUN	
		START TIME	/	0:00	00:00~23:59	
FORCE HOT WATER	/	/	OFF	OFF		
				ON		
DHW PUMP TIMER	START	/	0:00	00:00~23:59		
6	WEATHER CONTROL	ZONE 1 TEMP	/	/	OFF	OFF
						ON
		ZONE 1 COOL TEMP TYPE	/	/	OFF	OFF
						CURVE#1.L
						CURVE#2.L
						CURVE#3.L
						CURVE#4.L
						CURVE#5.L
						CURVE#6.L
						CURVE#7.L
						CURVE#8.L
						CURVE#1.H
						CURVE#2.H
						CURVE#3.H
						CURVE#4.H
						CURVE#5.H
						CURVE#6.H
						CURVE#7.H
		CURVE#8.H				
		CURVE#9				
ZONE 1 HEAT TEMP TYPE	/	/	OFF	OFF		
				CURVE#1.L		
				CURVE#2.L		
				CURVE#3.L		
				CURVE#4.L		
				CURVE#5.L		
CURVE#6.L						

Data classification: [00#module - user parameters]						
SN	First Menu	Secondary Menu	Third Menu	TERMINAL	Default	Range
6	WEATHER CONTROL					CURVE#7.L
						CURVE#8.L
						CURVE#1.H
						CURVE#2.H
						CURVE#3.H
						CURVE#4.H
						CURVE#5.H
						CURVE#6.H
						CURVE#7.H
						CURVE#8.H
						CURVE#9
		ZONE 2 TEMP	/	/	OFF	OFF
						ON
		ZONE 2 COOL TEMP TYPE	/	/	OFF	OFF
						CURVE#1.L
						CURVE#2.L
						CURVE#3.L
						CURVE#4.L
						CURVE#5.L
						CURVE#6.L
						CURVE#7.L
						CURVE#8.L
						CURVE#1.H
						CURVE#2.H
		CURVE#3.H				
		CURVE#4.H				
		CURVE#5.H				
		CURVE#6.H				
		CURVE#7.H				
		CURVE#8.H				
		CURVE#9				
		ZONE 2 HEAT TEMP TYPE	/	/	OFF	OFF
						CURVE#1.L
CURVE#2.L						
CURVE#3.L						
CURVE#4.L						
CURVE#5.L						
CURVE#6.L						
CURVE#7.L						
CURVE#8.L						

Data classification: [00#module - user parameters]						
SN	First Menu	Secondary Menu	Third Menu	TERMINAL	Default	Range
6	WEATHER CONTROL	ZONE 2 HEAT TEMP TYPE	/	/	OFF	CURVE#1.H
						CURVE#2.H
						CURVE#3.H
						CURVE#4.H
						CURVE#5.H
						CURVE#6.H
						CURVE#7.H
						CURVE#8.H
						CURVE#9
		ZONE 3 TEMP	/	/	OFF	OFF
						ON
		ZONE 3 COOL TEMP TYPE	/	/	OFF	OFF
						CURVE#1.L
						CURVE#2.L
						CURVE#3.L
						CURVE#4.L
						CURVE#5.L
						CURVE#6.L
						CURVE#7.L
						CURVE#8.L
						CURVE#1.H
						CURVE#2.H
						CURVE#3.H
						CURVE#4.H
						CURVE#5.H
		CURVE#6.H				
		CURVE#7.H				
		CURVE#8.H				
		CURVE#9				
		ZONE 3 HEAT TEMP TYPE	/	/	OFF	OFF
CURVE#1.L						
CURVE#2.L						
CURVE#3.L						
CURVE#4.L						
CURVE#5.L						
CURVE#6.L						
CURVE#7.L						
CURVE#8.L						
CURVE#1.H						
CURVE#2.H						

Data classification: [00#module - user parameters]						
SN	First Menu	Secondary Menu	Third Menu	TERMINAL	Default	Range
6	WEATHER CONTROL	ZONE 3 HEAT TEMP TYPE	/	/	OFF	CURVE#3.H
						CURVE#4.H
						CURVE#5.H
						CURVE#6.H
						CURVE#7.H
						CURVE#8.H
						CURVE#9
7	ECO SETTING	CURRENT STATE	/	/	OFF	OFF
						ON
		ECO MODE	/	/	STANDARD	STANDARD
						ECO
						TURBO
						AUTO
		ECO TIMER	/	/	OFF	OFF
						ON
		TIME PERIOD	/	/	00:00-00:00	00:00~23:59
8	SILENT FUNCTION SETTING	CURRENT STATE	/	/	OFF	OFF
						ON
		SILENT LEVEL	/	/	Level1	Level1
						Level2
		SILENT TIMER 1	/	/	OFF	OFF
						ON
		TIME PERIOD 1	/	/	00:00-00:00	00:00~23:59
		SILENT TIMER 2	/	/	OFF	OFF
						ON
		TIME PERIOD 2	/	/	00:00-00:00	00:00~23:59
9	CHILD LOCK	/	/	/	OFF	OFF
						ON
10	HOLIDAY AWAY FROM HOME	HOLIDAY AWAY FROM HOME	/	/	OFF	OFF
						ON
		DATE	/	/	/	2020-1-1 ~ 2099-12-31
		HEAT	/	/	OFF	OFF
						ON
		DHW	/	/	OFF	OFF
						ON
		STERILIZATION OF DHW	/	/	OFF	OFF
						ON
11	HOLIDAY AT HOME	HOLIDAY AT HOME	/	/	OFF	OFF
						ON

Data classification: [00#module - user parameters]								
SN	First Menu	Secondary Menu	Third Menu	TERMINAL	Default	Range		
11	HOLIDAY AT HOME	DATE	/	/	0000-0-0~0000-0-0	2020-1-1 ~ 2099-12-31		
		HOLIDAY AT HOME TIMER SET	START	/	/	0	00:00-23:59	
			END	/	/	0	00:00-23:59	
			MODE	/	/	HEAT	COOL HEAT DHW	
			TEMP ( R290)	/	/	45°C	5-80°C	
			TEMP ( R32)	/	/	45°C	5-65°C	
			12	WEEKLY TIMER	/	/	/	MON
/	/	/			TUE			
/	/	/			WED			
/	/	/			THU			
/	/	/			FRI			
/	/	/			SAT			
/	/	/			SUM			
SET TIME	START	/			/	0	00:00-23:59	
	END	/			/	0	00:00-23:59	
	MODE	/			/	HEAT	COOL HEAT DHW	
	TEMP ( R290)	/			/	45°C	5-80°C	
	TEMP ( R32)	/			/	45°C	5-65°C	
	13	DAILY SCHEDULE TIMER			START	/	/	0
END			/	/		00:00-23:59		
MODE			/	/	HEAT	COOL HEAT DHW		
			TEMP ( R290)	/	/	45°C	5-80°C	
			TEMP ( R32)	/	/	45°C	5-65°C	
			14	AHS RUN MODE	/	/	/	COMBINED
15	ELECTRICITY PRICE	/			/	/	0.25	0.00-2.00 €/kWh
		16			GAS PRICE	/	/	/

3. Exit from parameter setting

- (1) In the status of parameter setting, when you press the [ ⏪ ] key at any time, it will exit from the setting status and return to the home page.
- (2) After entering the parameter setting page, if there is no operation within 30 seconds, it will not save the set value(s) and exit from the parameter setting status and then return to the main interface.

4. Relevant parameters of master and slave indoor units:

- (1) You can set the parameters of the master indoor unit only via the corresponding wire controller of such indoor unit; you cannot do so via any other wire controller;
- (2) You can clear the settings of the master indoor unit via the corresponding wire controller of any indoor unit on the same network;
- (3) You can inquire the address of the master indoor unit via the corresponding wire controller of any indoor unit on the same network.

5. Correction of temperature sensitive package

- (1) Service value of temperature sensitive package = detected value of temperature sensitive package + correction value

### 3. Restoring to factory default settings

On the parameter setting page, if you first select the option [RESET] and then select the option [OK], you can restore the parameters of wire controller to factory default settings.

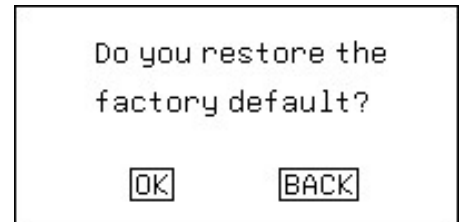

### 4. Error query

(1) On the query interface, you can select the error query interface by pressing the arrows [ ^ ], [ v ], [ < ] and [ > ] keys; at the moment, you will see that the current fault list pops up and you can press the option [OK] behind every fault code to access the detailed fault description. You can go back to the fault list by pressing the option [BACK], go back to the query interface by pressing the option [BACK] again and then go back to the main menu interface by pressing the option [BACK] once again.

(2) On the query interface, you can select the historical fault query interface by pressing the arrows [ ^ ], [ v ], [ < ] and [ > ] keys; at the moment, you will see that the historical fault list pops up and you can press the option [OK] behind every fault code to access the detailed fault description. You can go back to the fault list by pressing the option [BACK], go back to the query interface by pressing the option [BACK] again and then go back to the main menu interface by pressing the option [BACK] once again.

HISTORY ERROR	1/1
1. CURRENT ERROR	
2. HISTORY ERROR	
3. CLEAR HISTORY ERROR	
<b>OK</b>	^ v < > <b>BACK</b>

CURRENT ERROR	1/1
ERROR CODE NO.	
E5 00#	
<b>OK</b>	^ v < > <b>BACK</b>

HISTORY ERROR	1/1
ERROR CODE NO. OCCUR TIME	
E5 00# 2023.1.4 15:30	
<b>OK</b>	^ v < > <b>BACK</b>

## 5. Error List

S.N.	Name of parameter	Description
1	d1	Abnormal outlet water temperature after auxiliary heating
2	d2	Abnormal temperature of plate heat exchange inlet water
3	d3	Abnormal temperature of plate heat exchange outlet water
4	d4	Plate heat exchanger refrigerant gas pipe is abnormal
5	d5	Plate heat exchanger refrigerant liquid pipe is abnormal
6	d6	Abnormal final outlet water temperature of the system
7	d7	Zone 1 inlet water temperature abnormal
8	d8	Zone 2 inlet water temperature abnormal
9	d9	Zone 3 inlet water temperature abnormal
10	dA	Zone 1 room temperature abnormal
11	db	Zone 2 room temperature abnormal
12	dC	Zone 3 room temperature abnormal
13	dF	The inlet water temperature of the balance tank is abnormal
14	dH	The outlet water temperature of the balance tank is abnormal
15	dj	Abnormal temperature of solar panel
16	dn	Abnormal temperature of solar panel
17	L1	The water temperature difference between plate heat exchanger inlet and outlet is too large
18	L2	The water temperature difference between plate heat exchanger inlet and outlet is abnormal
19	L3	Plate heat exchanger outlet water temperature is too low
20	L4	Plate heat exchanger outlet water temperature is too high
21	L5	Plate heat exchanger inlet water temperature is too low
22	L6	Plate heat exchanger inlet water temperature is too high
23	L7	Water side antifreeze
24	L8	Insufficient water flow fault
25	Lb	Auxiliary electric heating feedback failure
26	LC	Water tank electric heating feedback failure
27	Ld	Emergency frequent defrosting
28	LE	External water pump failure
29	LP	External water pump failure
30	C1	Multiple master control failure
31	C7	WiFi communication failure
32	E0	Communication failure between indoor unit and outdoor unit
33	E3	The temperature sensor in the middle of the plate heat exchanger is faulty
34	E4	Refrigerant leak fault
35	E5	DIP abnormal
36	E7	Outdoor temperature sensor failure
37	E8	Exhaust temperature sensor failure
38	EA	Outdoor current sensor failure
39	Eb	Communication failure between indoor unit and wire controller
40	EC	Communication failure between drive board and main PCB
41	Ed	indoor unit EE error
42	EE	Outdoor EEPROM failure
43	EF	Outdoor DC fan failure
44	EH	Malfunction of outdoor air intake sensor
45	Ej	Communication failure between indoor unit and thermostat

S.N.	Name of parameter	Description
46	En	module communication error
47	F2	Outdoor exhaust temperature sensor failure protection
48	F3	Outdoor coil temperature sensor failure protection
49	F5	PFC protection
50	F6	Compressor loss/reverse phase protection
51	F7	Module temperature protection
52	F8	4 way valve reversing failure (heating mode)
53	FA	Compressor phase current detection failure
54	Fy	lack of refrigerant
55	H1	High pressor switch protection
56	H2	Low pressor switch protection
57	H3	High pressure sensor failure
58	P0	IPM module protection, compressor overcurrent, IPM overcurrent, inverter module protection
59	P1	DC bus overvoltage, undervoltage, voltage overvoltage, undervoltage, AC input undervoltage
60	P2	High Outdoor Exhaust AC input overcurrent
61	P4	Anti-Exhaust temperature too high protection
62	P5	Refrigeration anti-overcooling failure
63	P6	Refrigeration prevents overheating failure
64	P7	Heating protection against overheating
65	P8	Outdoor ambient temperature too high and too low protection

## VII. Installation instruction

---

### 1. Material chart list

Serial number	Name	Quantity
1	Communication cable	x1
2	Wire controller	x1
3	Screw	x2

### 2. Installation steps for installing the wire controller separately to the indoor wall

1). Use the tool to pry the front and rear covers of the wire controller from the lower buckle.

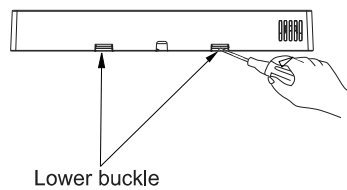

2) Pass the communication cable of the accessory through the opening of the rear cover, and stick the communication cable in the cable slot of the rear cover. Reserve 50mm-60mm length in the wire controller.

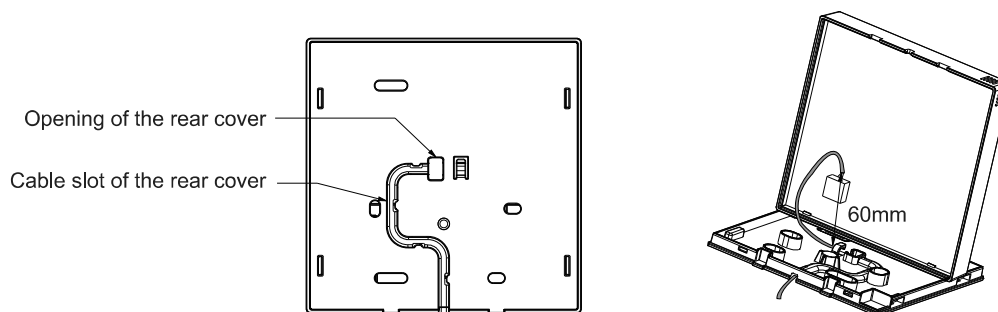

3).Use the screws(accessory) to install the rear cover of the wire controller on the wall.

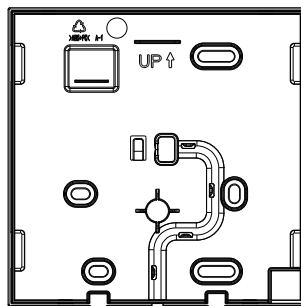

4).Connect the communication cable to the main board of the wire controller.

5).Fasten the front cover and rear cover of the wire controller.

